

4 Mecanizado / Usinagem / Machining



- Utilizar con cristal templado.
- Use with tempered glass.
- Usar com vidro temperado.

- Es requisito perforar el cristal para la instalación del sistema en zonas de mucha humedad y calor.

- É requerido fazer os furos no vidro para a instalação do sistema em áreas de elevada humidade e calor.

- It is required to make the holes system for installation in areas of high humidity and heat.

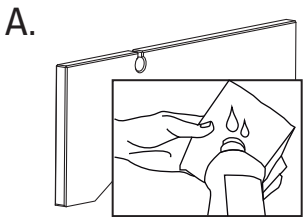
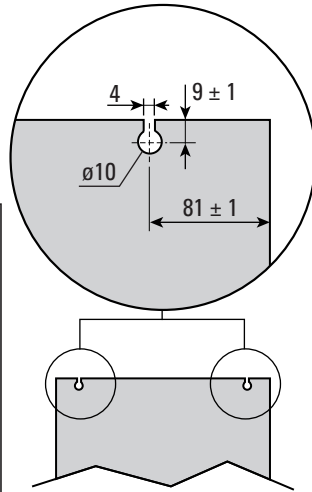

Limpiar con alcohol.
Limpe com álcool.
Clean with alcohol.

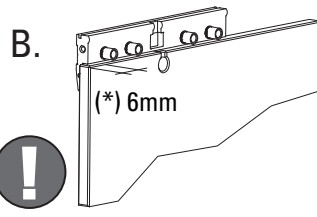

(*) Con o sin cristal perforado.
With or without perforated glass.
Com ou sem vidro perforado.

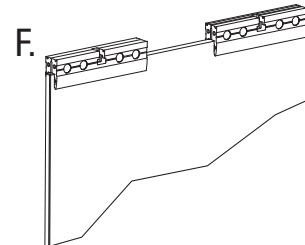
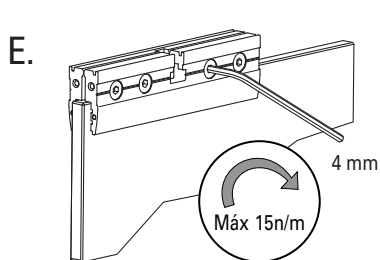
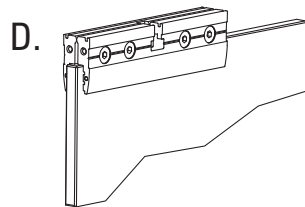
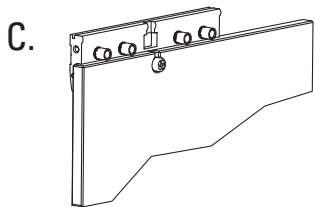

4.1

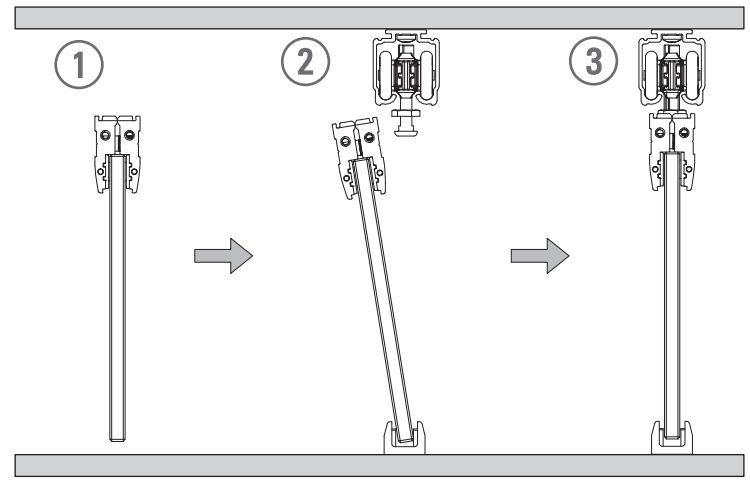

4.2

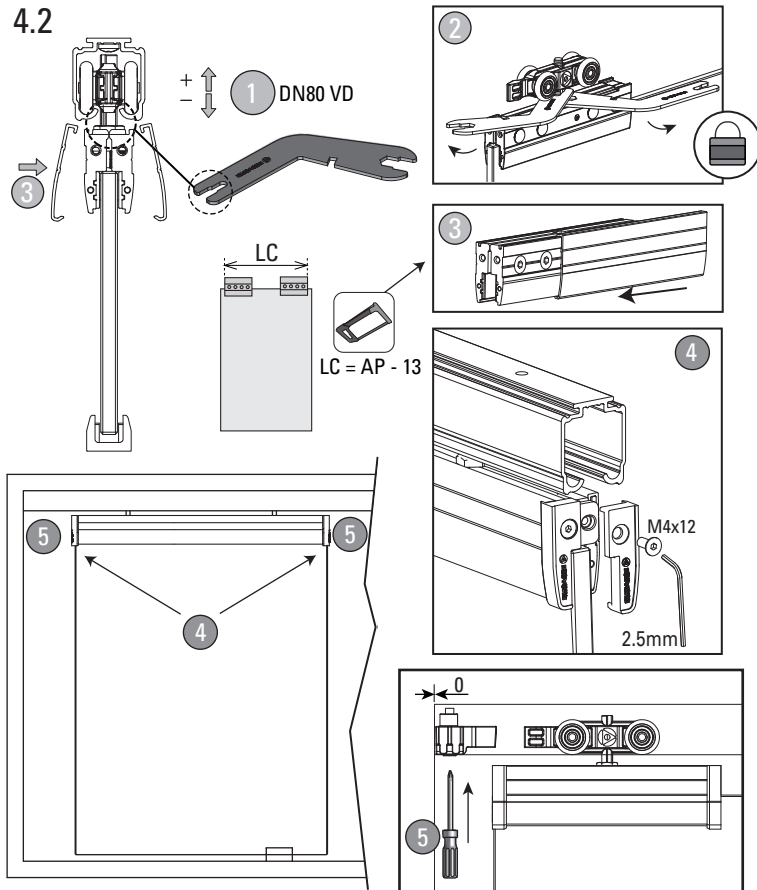

4.3

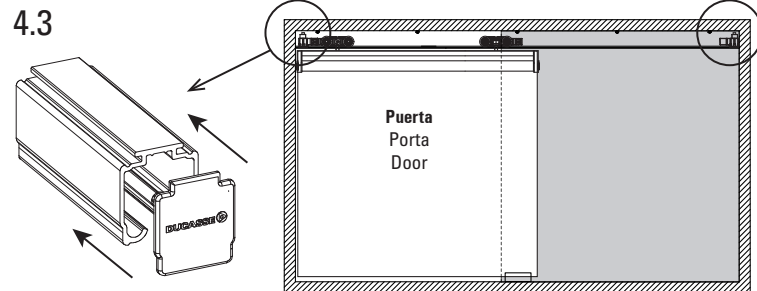

Todas las medidas expresadas en milímetros.
Todas as medidas estão em milímetros.
All measurements in milimeters.

mm	Decimal inches	Aprox Fraction	mm	Decimal inches	Aprox Fraction
1	0.0394	3/64	6	0.2362	15/64
2	0.0787	5/64	7	0.2756	9/32
3	0.1181	1/8	8	0.3150	5/16
4	0.1575	5/32	9	0.3543	23/64
5	0.1969	13/64	10	0.3937	25/64

V07.11.18

OP

www.ducasseindustrial.com

DUCASSE INDUSTRIAL