

# D-52



Peso máx. puerta  
Peso max. porta  
Max. Door weight



Dos puertas  
Duas portas  
Two doors



Espesor Madera  
Espessura Madeira  
Wood Thickness



Ancho mínimo  
Largura mínima  
Minimum width



Riel AL D-52  
Trilho AL D-52  
Carrier track D-52



Guía AL D-52  
Guia AL D-52  
Guide track D-52 AL



Kit AI D-52



Carrier track D-52

Guide track D-52 AL

## COMPONENTES / COMPONENTES / COMPONENTS

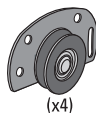

(x4)

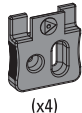

(x4)

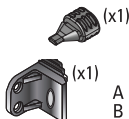

(x1)



A (x19) - #8\*5/8"  
B (x8) - 4\*15mm



ø48 - 50  
1"7/8 - 2"

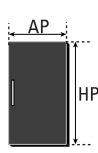
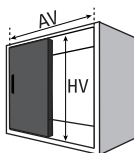

1.A  
HP = HV - 10  
AP = AV/2 + 15

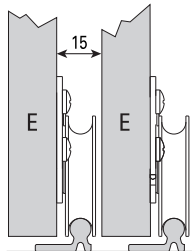

1.B  
HP = HV - 17  
AP = AV/2 + 15

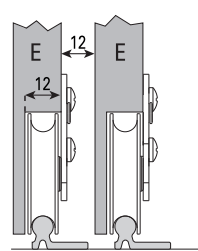

1

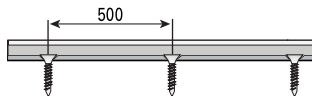
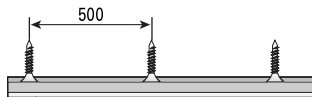

3.5\*20  
(#6\*3/8")

No incluido  
Nao incluso  
Not included

Todas las medidas  
expresadas en milímetros

Todas as medidas estão  
em milímetros.

All measurements in  
millimeters.

mm	Decimal inches	Aprox Fraction	mm	Decimal inches	Aprox Fracti
1	0.0394	3/64	6	0.2362	15/64
2	0.0787	5/64	7	0.2756	9/32
3	0.1181	1/8	8	0.3150	5/16
4	0.1575	5/32	9	0.3543	23/64
5	0.1969	13/64	10	0.3937	25/64

1.A

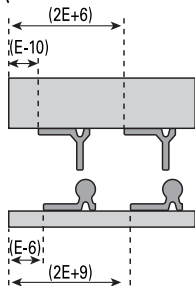

1.B

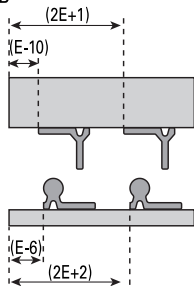

2

2.A

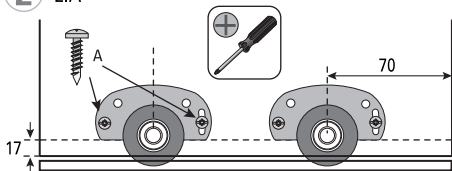

2.B

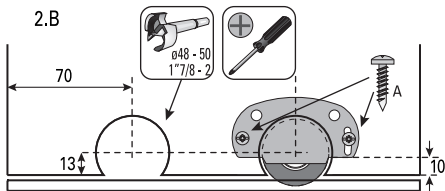

3

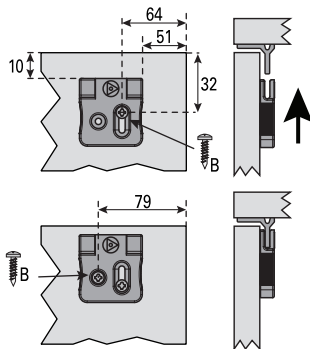

4

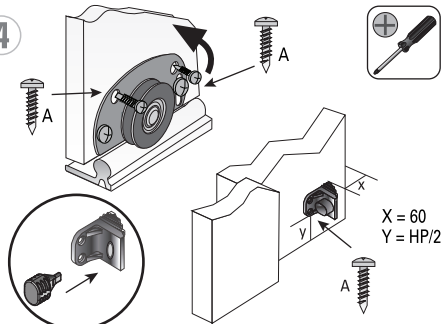

V04.04.18

OP

**DUCASSE**  
 INDUSTRIAL