

PL 2550

- 2x20kg**
44 lbs
Peso máx. puerta /
Peso max. porta
Max. Door weight
- 12**
Dos puertas /
Duas portas
Two doors
- $\geq 18\text{mm}$ EP
 $\geq 3/4"$
Espesor Madera /
Espessura Madeira
Wood Thickness
- $\leq 500\text{mm}$
 $\leq 19" 11/16$
Ancho Madera /
Largura Madeira
Wood width

- 23** / **27**
Riel PL 2550 /
Trilho PL 2550 /
Carrier Track PL 2550
- $\geq 43\text{mm}$

COMPONENTES / COMPONENTES / COMPONENTS

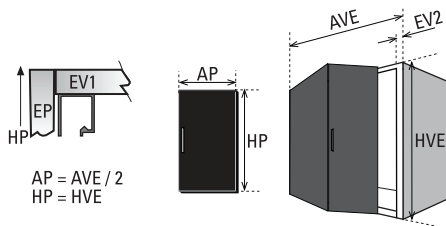
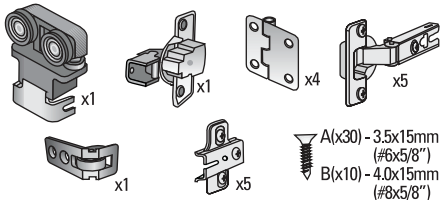

EV2 ≥ 18

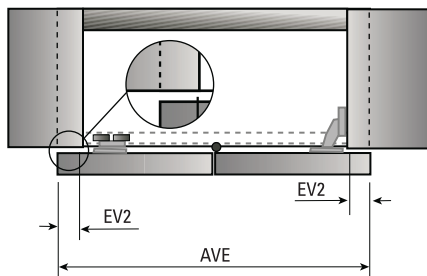

Todas las medidas expresadas en milímetros / Todas as medidas estão em milímetros. / All measurements in millimeters.

mm	Decimal	Aprox Fraction	mm	Decimal	Aprox Fraction
1	0.0394	3/64	6	0.2362	15/64
2	0.0787	5/64	7	0.2756	9/32
3	0.1181	1/8	8	0.3150	5/16
4	0.1575	5/32	9	0.3543	23/64
5	0.1969	13/64	10	0.3937	25/64

EP \geq EV2

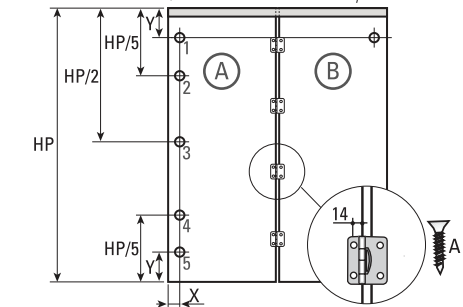
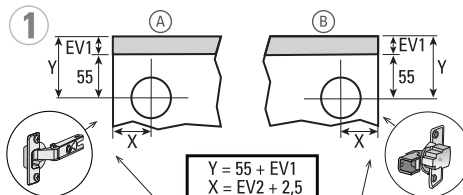
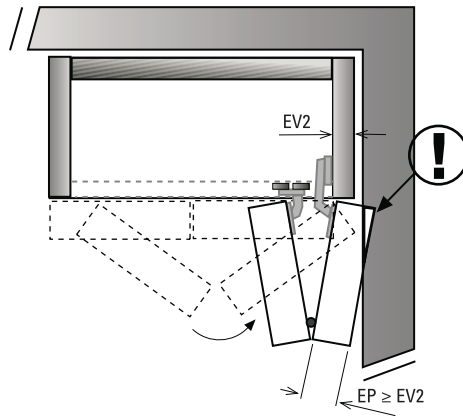

HP < 900	x2	1 y 5	
HP = 900 - 1600	x3	1, 3 y 5	
HP > 1600	x5	1, 2, 3, 4 y 5	

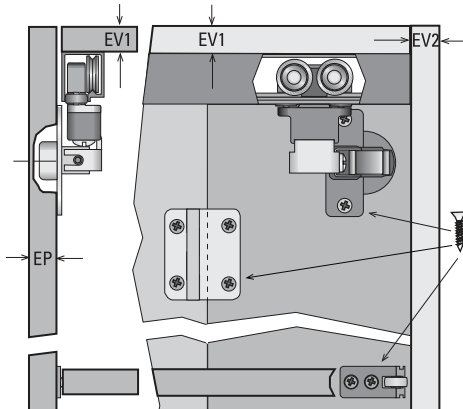

2

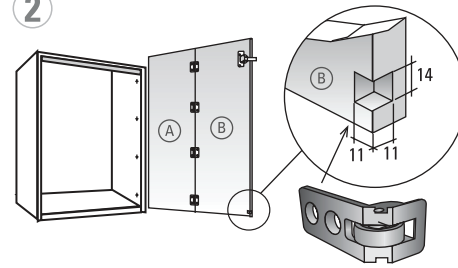

3

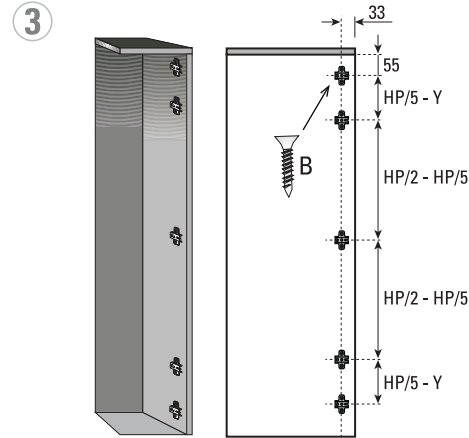

4

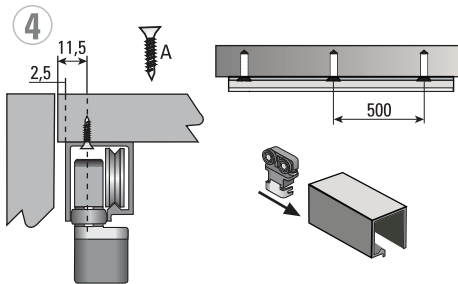

5

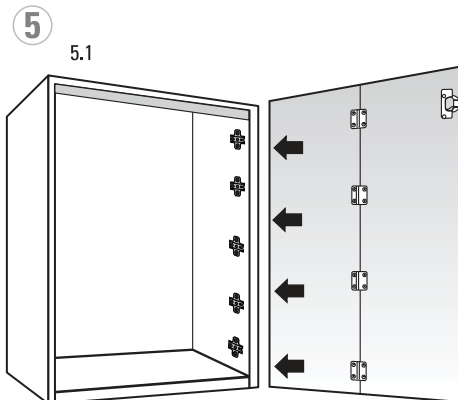

5.2

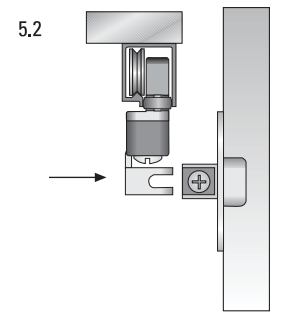

5.3

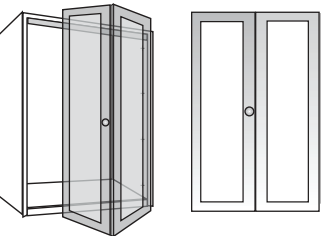
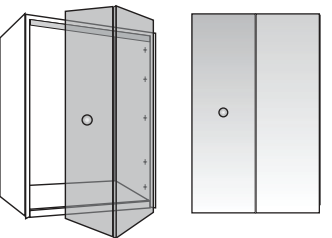
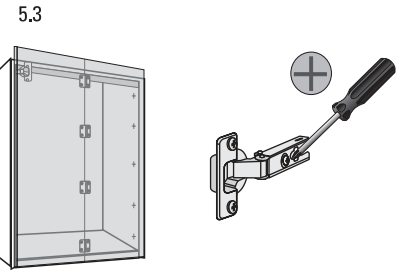

V23.05.18

OP