



CANTIDAD DE PUERTAS



MONTAJE DE PUERTA DENTRO DE VANO



MONTAJE DE CARRO COLGANTE

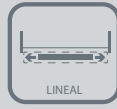

MOVIMIENTO DEL SISTEMA LINEAL



CAPACIDAD DE CARGA POR HOJA 10-30 kg SIMPLE

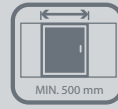

ANCHO DE PUERTA MIN. 500 mm



ESPESOR DE PUERTA 15 - 30 mm



MATERIAL DE PUERTA MADERA



LUZ SUPERIOR | INFERIOR  $\geq 8$  mm |  $\geq 10$  mm



ALTURA MARCO DE PUERTA  $\geq 32$  mm

VMX01\_1020



D7-D14 SIMPLE

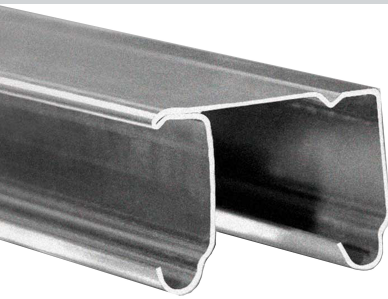

Riel U20 Galvanizado

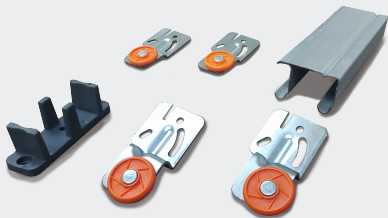

Kit Ducloset Simple

Kit integral de herrajes para puertas corredizas que facilitan la instalación de 2 puertas máximo 30 kilos con rodamiento de polín.

**USOS**

- | Puertas de clóset



**CUALIDADES**

- | La geometría del riel y el alineamiento de la guía al piso entregan mayor seguridad de sujeción.
- | Guía al piso ajustable para distintos espesores de hoja.
- | El tope evita el solapamiento completo de las puertas.
- | El Kit incluye: Carretillas, Guías, y Riel de 2 o 3 metros.
- | Sistema 32.



# KIT CLOSET D7-D14 GALV.

## SISTEMAS CORREDIZOS



TIPO DE RODAMIENTO



RESISTENCIA A LA CORROSIÓN



NORMA ANSI - BHMA



NORMA UNE - EN

### INSTALACIÓN

#### Esquema General

Vista Frontal

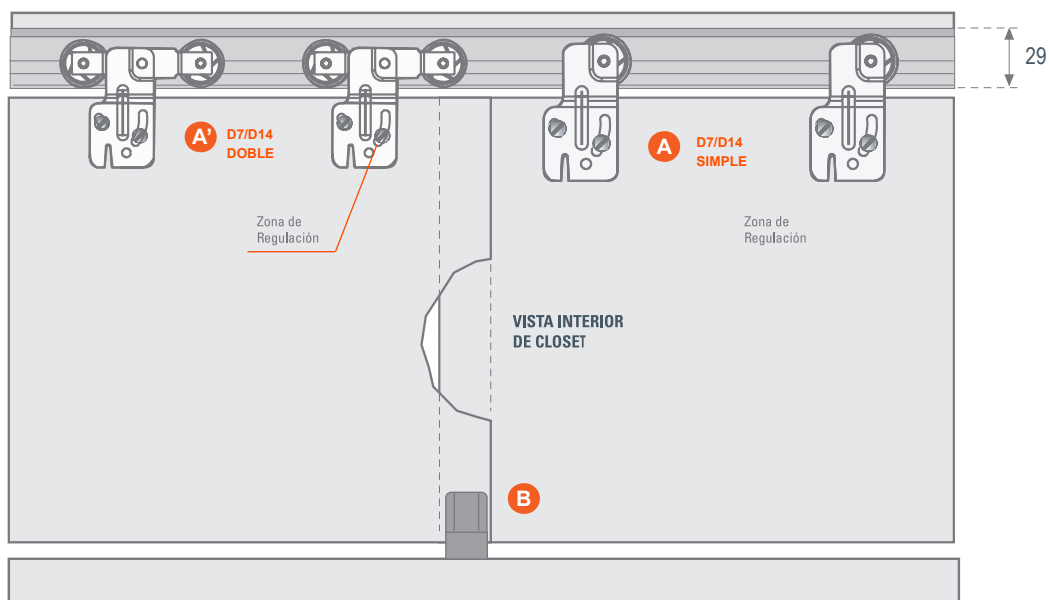

Vista Lateral

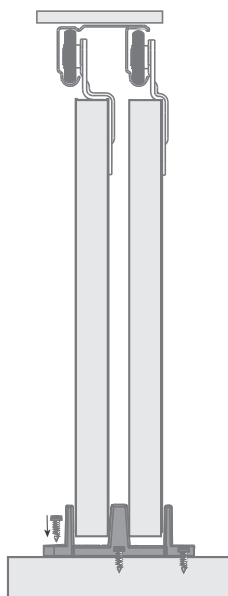

Guía se ajusta al espesor de la madera

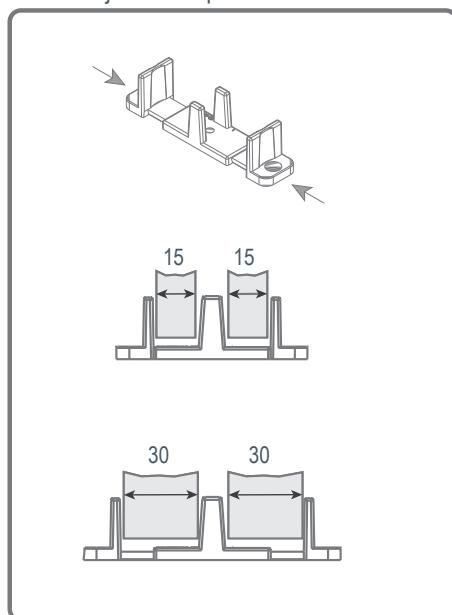

### KIT DUCLOSET D7-D14

#### | para 2 Hojas |

2 mts.	51110200021 / 1 un.
2.5 mts.	51110250021 / 1 un.
3 mts.	51110300021 / 1 un.

- A** 4 Carros D7-D14 Simple
- B** 1 Guía al piso 2040 N (1635)
- C** Tornillos
- D** Riel U-20 Gal. de 2 o 3 mts.

CHILE  
 info@ducasseindustrial.cl

ARGENTINA  
 info@ducasse.com.ar

PERÚ  
 info@ducasseindustrial.com.pe

COLOMBIA  
 info@ducasseindustrial.com.co

BRASIL  
 info@ducasse.com.br

MÉXICO  
 info@ducasseindustrial.com.mx

WWW.DUCASSEINDUSTRIAL.COM/MX