



CANTIDAD  
DE PUERTAS



MONTAJE  
DE PUERTA



MONTAJE  
DE CARRO



MOVIMIENTO  
DEL SISTEMA



CAPACIDAD DE  
CARGA POR HOJA



ESPESOR  
DE PUERTA

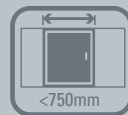

ANCHO DE  
PUERTA



MATERIAL DE  
PUERTA

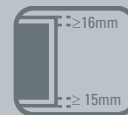

LUZ  
SUPERIOR | INFERIOR



DN 80 PL 2



Sistema corredizo colgante para 2 puertas plegables, de suave y silencioso desplazamiento.

### USOS

- | Puertas de closet
- | Divisiones de ambientes
- | Puertas y celosías plegables

### CUALIDADES

- | Sistema de montaje no requiere de laterales en el vano.
- | Ideal para divisiones de ambientes o soluciones de closet.
- | Posibilidad de utilizar puertas de hasta 750 mm de ancho.
- | Rodamientos de alta calidad y riel de aluminio permiten un deslizamiento suave y silencioso.



ESTANDAR  
TIPO DE RODAMIENTO



96 HORAS  
RESISTENCIA A LA CORROSIÓN



G° 1  
NORMA ANSI - BHMA



G° 3  
NORMA UNE - EN

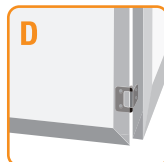
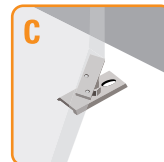
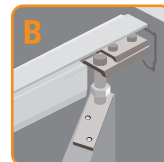
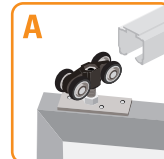
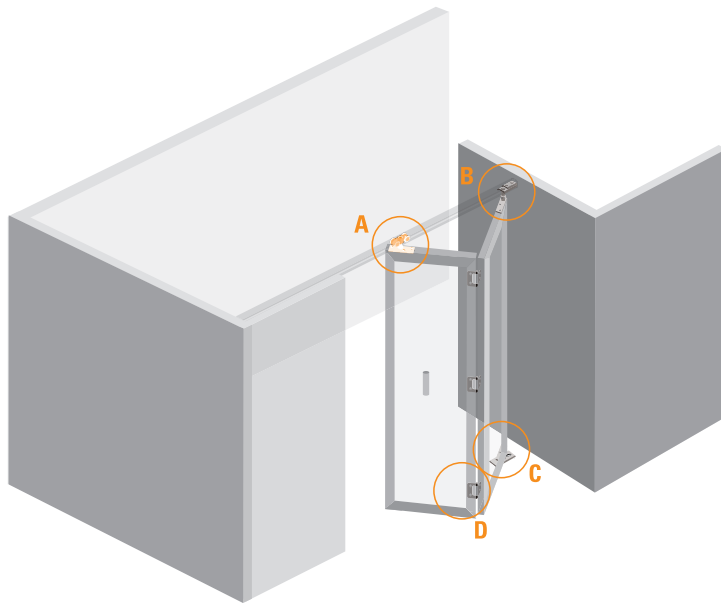

Vista Frontal

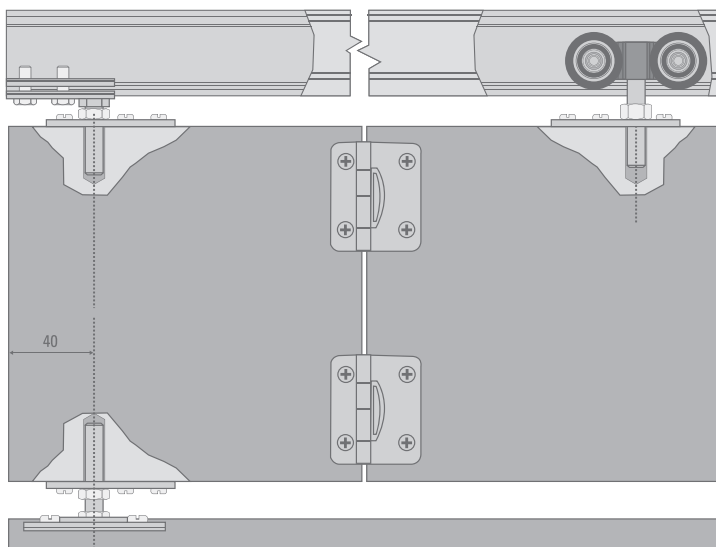

Vista Lateral U 21

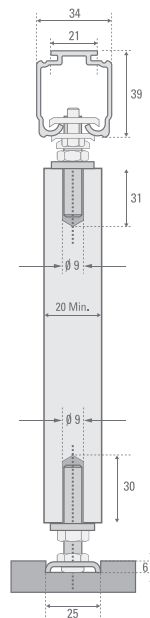

## DN 80 PL 2 H | para 2 Hojas |

10100217301  
Mínimo de despacho: 10 unidades

- |          |                          |  |
|----------|--------------------------|--|
| <b>A</b> | 1 Carro DN 80 PL         |  |
|          | 1 Pletina DN 80 PL       |  |
| <b>B</b> | 1 Base Superior DN-80 PL |  |
|          | 1 Pletina DN-80 PL C/H   |  |
| <b>C</b> | 1 Base Inferior DN 80 PL |  |
|          | 1 Pletina DN 80 PL       |  |
| <b>D</b> | 3 Bisagra excéntrica     |  |
| <b>E</b> | 1 Alineador              |  |
| <b>F</b> | 1 Llave de regulación    |  |
| <b>G</b> | Fijaciones               |  |

### SE USA CON:

- |  |  |
|--|--|
|  | <b>RIEL U-21 PORTACNEFA AL</b><br>2.0 m. 54033620024<br>3.0 m. 54033630024<br>6.0 m. 54033660024 |
|  | <b>RIEL U-21 ESTANDAR AL</b><br>2.0 m. 54033520024<br>3.0 m. 54033530024<br>6.0 m. 54033560024   |
|  | <b>RIEL U-100 ACERO</b><br>2.0 m. 10100612020<br>3.0 m. 10100612030                              |